

LOKTHOR



The Force of Thunder in Hand

Contents

Safety Instructions	05
Product Overview	05
Operating Procedure	07
1.How to power up the jump starter	07
2.How to use the jump-start function	08
3.How to use voltmeter function	08
4.How to use the air inflator function	09
5.LED light	10
6.How to charge your jump starter	10
7.How to use the 5V USB-A port to charge your mobile phone	10
8.Error code display description	11
Warnings	12
Recycling Treatment	12
Warranty Policy	12

Thank you for purchasing products of LOKITHOR, please read this manual carefully before use, and properly save for future reference

Safety Instructions

Please read the following instructions carefully before using the LOKITHOR multi-function vehicle emergency starter (hereinafter referred to as the jump starter):

1. Please strictly follow the instruction manual to operate. If used improperly, or against the instructions, it may cause a serious safety incident;
2. Only for starting 12V engine and can not start vehicles exceeding specified displacement or voltage;
3. Under the forced start mode, part of the security protection mechanism is invalid, so please use with caution, and check the instruction manual before usage;
4. If you start to pump up your tires without setting a target tire pressure value, the air inflator will not automatically stop pumping and instead you will need to manually stop it. There's risk of over-inflated tires or a blowout condition if the tire pressure is not kept under observation in real time;
5. The air inflator generates heat when used, especially at the air nozzle. Do not touch the air inflator immediately after pumping, and we suggest you wear gloves to protect yourself against burning;
6. In order to prolong the the life of battery, please charge the device after purchase, and charge and discharge the device every three months to ensure that it is in good condition for the next use;
7. Do not use a jump starter that has been severely hit, dropped or other damaged;
8. Please do not disassemble the jump starter without authorization. Please contact a professional maintenance personnel for repairing the jump starter;
9. When the jump starter is charging, do not use it to start the vehicle;
10. Be extra cautious during operation to avoid metal tools falling on the jump starter interface (it is easy to cause a short circuit, equipment damage, or an explosion);
11. When using the jump starter, ensure that the surrounding area is well ventilated;
12. When starting the vehicle, make sure that the positive and negative contact points on the cable clamp of the jump starter are in good contact with the positive and negative poles of the battery;
13. Sparks and flames contacting the jump starter and engine is forbidden;
14. In order to prevent sparks from short-circuiting and damaging the jump starter, it is forbidden to clamp the positive and negative poles of the clamp together or touch the same metal;
15. Do not place the jump starter where children can reach it;
16. Do not expose the jump starter to rain or snow;
17. Do not leave the device in extreme environments for a long time (high temperature: above 131°F (55°C), extreme cold: below 14°F (-10°C), humid: humidity> 80%);
18. Please store the jump starter in a cool and dry place, and take protective measures if necessary;
19. Please charge the product in time to prevent battery low-voltage or out of power. Long time no power status of battery may cause the product to fail to charge.

Product Overview

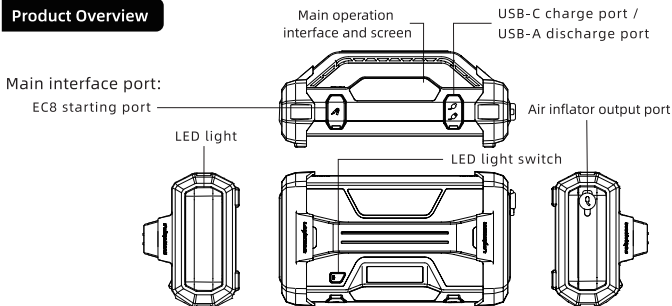

Main operation interface and screen

1.Interface display

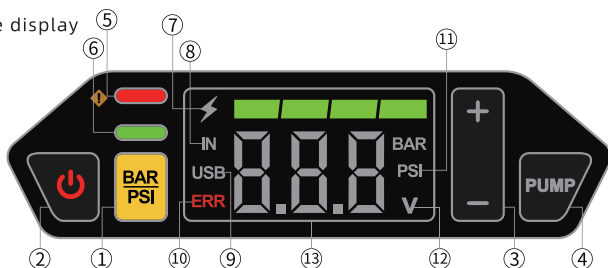

2.Description

No.	Functional Description	No.	Functional Description
1	BAR/PSI unit switch button, and it can also be used as a forced start function switch	2	Power button (Short press to turn on, long press for 2 seconds to turn off)
3	The button for presetting tire pressure: When the tire pressure is presetting, numbers will blink; The blinking will stop after the setting is completed. You may then exit the setting mode. At the same time, the real-time tire pressure will be displayed on the screen	4	Air inflator start-stop button: Hold down the button for 3 seconds to turn on. Press down quickly to turn off
5	Red light (Abnormal warning indicator for emergency jump start function)	6	Green light (ON: Forced start mode output; Blinking: Normal start mode output)
7	Battery indicator light (Power: 20%、40%、60%、80%、100%;Charging: Marquee)	8	IN: Charging status indicator
9	USB: USB Status Indicator	10	ERR: abnormal state alarm indicator
11	BAR / PSI: Tire pressure units setting indicator light	12	V: Output voltage detection status indication and units
13	Numerical display area		

Operating Procedure

1. How to power up the jump starter?

Press the "Light" or "Power" button

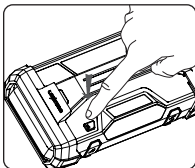

2. How to use the jump-start function?

2.1 Method one: Normal start

2.1.1 Connect the jump starter clamps with the EC8 connector to the jump starter.

2.1.2 Connect the red (+) clamp to the positive (+) terminal on the vehicle battery and the black (-) clamp to the negative (-) terminal on the vehicle battery, and make sure that the connections are good.

2.1.3 Press the "Light" or "Power" button to power on the product. The green light on the screen will light up and flash if there are no issues. At this time, you'll be able to start your vehicle.

2.1.4 If the vehicle starts successfully, the jump starter will automatically disable the power output.

2.1.5 In most cases, the vehicle will be able to start immediately after the jump starter has been connected. Some vehicles may need to be connected to the jump starter for 30~120 seconds (the product will charge the car battery at this time) to continue the operation. If the vehicle does not start immediately, Please wait 20-30 seconds before each attempt. Do not attempt more than five times within 15 minutes.

2.1.6 Please remove the jump-start clamps from the car battery instantly after you finished the starting. Pressing on the "Power" button for 2 seconds to shut down jump starter. If there are no operations for 60 seconds, the product will automatically shut down.

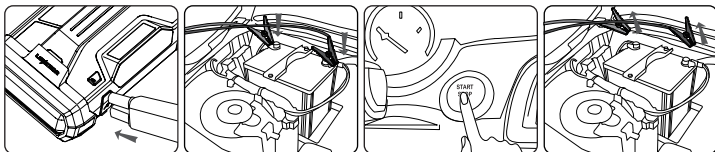

2.2 Method two: Forced start

(Safety reminder: Under the forced start mode, part of the safety protection mechanism is invalid. Be sure to connect the positive and negative poles correctly, otherwise it will cause a short-circuit. So please check the instruction manual before operation and use with caution)

2.2.1 At this time, the normal start mode fails to start , e.g: the voltage of the car battery is very low (the voltage is less than 1V),you can use the forced emergency start function after checking the operating specifications in the manual;

2.2.2 Connect the jump starter clamps to the EC8 connector on the Jump-Starter;

2.2.3 When the jump starter is on, tapping and holding on the "BAR/PSI" button for 5 seconds will enter the forced start mode. At this time, the green light on the screen is always lighting, which means that the output of the ignition clips are normally turned on. At this time, you must prevent the positive and negative poles from being short-circuited; (In this mode, it is required to turn on the forced start function first, and then connect the ignition clips to the car battery, otherwise the output cannot be turned on);

2.2.4 Connect the red (+) clamp to the positive (+) terminal on the vehicle battery and the black (-) clamp to the negative (-) terminal on the vehicle battery(during the connection process, there will be a slight sparking phenomenon, which is normal) and make sure that the connections are good; At this time, the overall voltage of the jump starter connected in parallel with the vehicle is displaying on the screen, then you can jump-starting the vehicle;

2.2.5 Shortly press the "Power"  or "BAR/PSI"  button to exit.

3. How to use voltmeter function

3.1 Connect the jump starter clamps to the EC8 connector on the Jump-Starter;

3.2 Connect the red (+) clamp to the positive (+) terminal on the vehicle battery and the black (-) clamp to the negative (-) terminal on the vehicle battery, and make sure that the connections are good;

3.3 At this time, the green light on the main interface flashes, and the overall positive and negative voltages of the starting power supply connected in parallel with the car are displayed at the same time, and it enters the starting mode. To check only the voltage of the car battery, short press the "ON" button to exit the starting mode and enter the measurement Mode, the "green light" goes out, the display only displays the voltage value of the car battery, so as to determine whether the battery is damaged;

3.4 Disconnect the alligator clamps from the vehicle battery and exit the voltmeter function mode.

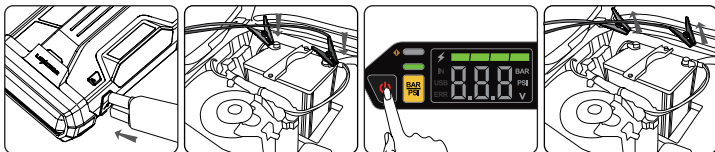

4. How to use the air inflator function?

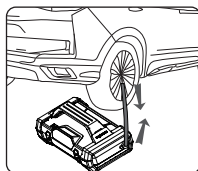
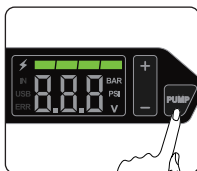
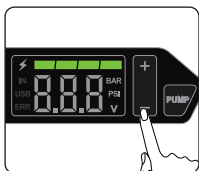
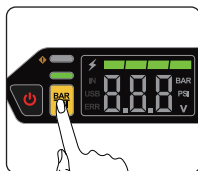
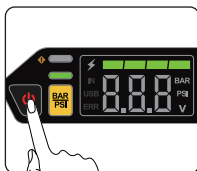
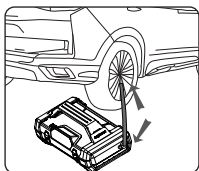

4.1 The inflatable hose is connected to the output port of the air inflator, and then tighten the nut, and the other end is connected to the car tire;

4.2 To wake the product (short press the "Light" button or short press the "Switch" button) to enter the air inflator mode;

4.3 Short press the "BAR/PSI" button to switch the pressure unit of tire pressure: BAR, PSI;

Pressure conversion table	Unit	Bar	kPa	PSI	Kgf/cm2
	Value	1	100	14.5	1.02

4.4 To set the target tire pressure value, you must first know the tire pressure requirements of the tire. (For the standard tire pressure value of the tire, you can check the pressure value mark on the tire, or check the manual of the inflated product), set the target tire pressure value by pressing "+ -". After setting, the value will flash for 3 seconds, exit the setting state and enter the real-time monitoring state of tire pressure;

(Safety reminder: If the target tire pressure value of the tire is not set, directly turn on the air pump. At this time, the air pump will not automatically charge and stop. It needs to be turned off manually. If the tire pressure is not monitored in real time, there will be The risk of excessive tire pressure or puncture)

4.5 Long Press the "PUMP" button for 3 seconds to turn on the air inflator. When the tire pressure reaches the set value, the air inflator will be turned off automatically. To turn off the inflator manually: press the "PUMP" button or the "Switch" button;

4.6 Remove the inflatable hose.

(Safety reminder: During the inflation process, the heat generated by the air inflator will cause local high temperature. Please leave the product for 10 minutes to dissipate heat before removing the inflation tube to prevent scalds)

5. How to use LED light?

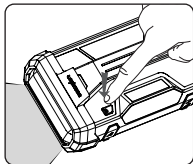

- ① Long press the "Light" button for one second, the LED lights up;
- ② Short press the "Light" button in order to switch the modes of ON, Strobe, SOS and OFF;
- ③ Long press the "Light" button for two seconds to turn off the LED light forcefully.

6. How to charge your jump starter

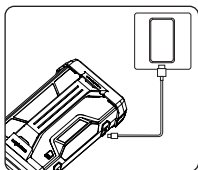

6.1 You will need the following: USB power adapter(5V output USB power adapter or 9V2A USB power adapter if QC protocol supported) and a USB To Type-C cable.

6.2 Plug the USB plug/A Port into the power adapter and the C port into the jump starter's charging port. At this point, the battery indicator and the "In" icon on the screen will turn on, indicating that the product is charging.

6.3 In the case of running out of power or low power, please charge the product in time to prevent battery under-voltage. Long-term no power status of battery may cause the product to fail to charge.

7. How to use the 5V USB-A port to charge your mobile phone

7.1 You will need the following: USB To USB-C cable and a mobile phone (if the mobile phone supports 9V2A of QC protocol, it can support 9V2A fast charge);

7.2 When the "USB" icon on the screen light up, plug the USB plug/A Port to the jump starter and the C port into your mobile device.

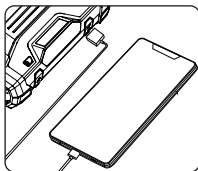

8. Error code display description

NO.	ERROR CODE	EXPLANATION	REASON/SOLUTION
1	001	When charging or starting, other functions are not allowed	Disconnect the charger or exit the start mode
2	110	Charging overvoltage protection	Disconnect the charger
3	111	Charging over-voltage (secondary) protection	Disconnect the charger
4	120	Charging over temperature protection	Wait for the product to cool down
5	130	Charging under temperature protection	Put the product at the right temperature
6	140	Discharge undervoltage protection	Connect the charger
7	150	Discharge over temperature protection	Wait for the product to cool down
8	160	Discharge under temperature protection	Put the product at the right temperature
9	200	Communication abnormal	Restart the device
10	310	Air inflator short-circuit protection	Restart the device
11	320	Air inflator over-current protection	Restart the device
12	330	When starting, the current air Pressure is greater than the set air pressure	Reset the proper air pressure
13	410	When starting, under-voltage protection	Connect the charger
14	411	Before starting, under-voltage protection	Connect the charger
15	420	Start over temperature protection	Wait for the product to cool down
16	430	The external battery voltage is greater than the device voltage	1. The display voltage is lower than 12V, and the device voltage is low. Please connect the charger to recharge. 2. If the display voltage is higher than 12V, the car battery is normal; or the car battery voltage is too high, which is not suitable for this product, please use an jump starter that supports higher voltage
17	440	Ignition clip shorted	Connect the battery correctly
18	450	Abnormal clamp connection	Connect the battery correctly
19	460	Start short circuit protection	Restart the device
20	470	Abnormal cell voltage drift protection	/
21	480	Continuous start protection	Wait 30 seconds and start again

Warnings

*** Do not disassemble the product as there are no user-serviceable parts. Any maintenance should be operated by professional maintenance-specialist staff.**

1. Quickly starting your vehicle can be possible when the jump-starter battery's capacity is more than 50% although your vehicle may not be able to start effectively if the jump starter does not have enough sufficient power.
2. It is normal for the jump starter to heat up after it is turned on or while the air inflator function is being used.
3. In order to maintain optimal the life of battery, charge the jump starter at least once every 3 months.
4. If the jump starter start to leak or emit any peculiar smell, stop using it and contact us immediately.
5. Do not connect the red clamp with the black clamp as this can be dangerous.
6. Use the original jump starter clamps only.
7. Stay away from fire and water to avoid safety accidents.
8. Do not place the jump starter in an environment with temperatures above 60°C and do not allow it to have prolonged exposure under sunlight. Store the jump starter in a cool and dry place.
9. Do not disassemble or modify this product without approval.
10. Do not violently knock, press or shake the jump starter; otherwise, it may cause a fire, explosion or combustion.
11. Do not use chemical cleaners to clean this product.
12. Keep this product away from children.

Recycling Treatment

1. To avoid irreparable harm to the environment or human beings, do not dispose the jump starter with other household garbage.
2. Separate the device from other types of garbage and recycle it in a responsible manner to maintain sustainable use of materials.

Warranty Policy

We offer a limited warranty on the product 12 months from the date of purchase on any defects in materials and workmanship. Conditions are as follows:

1. The buyer must provide proof of receipt (details on the order page/invoice, etc.) from the official dealer channel to apply for after-sales service.
2. The warranty does not cover damage or malfunction caused by normal wear and tear, physical damage, improper installation, misuse, or modification or unauthorized repairs by third parties.
3. The manufacturer shall not be liable for any loss or damage caused in transit by a third party or by force majeure.
4. The manufacturer is not responsible for any incidental or consequential damages arising from the use or misuse of this product.
5. All warranty claims are limited to the repair or replacement of defective products and are at our sole discretion.
6. If we repair or replace the product, the product will be covered for the remainder of the original warranty period. We reserve the right to repair or replace refurbished equipment, products or accessories which may involve the use of the same functions.
7. Consumable parts, such as batteries, are not covered by the warranty.
8. The manufacturer reserves the right to change and interpret these terms and conditions of the warranty at its own discretion.